

Product: Standard 2000 Timber

Description:

Modular bench unit with stainless steel straps securing oiled Iroko timber top for the Adapt range, designed to be used in an arrangement or as a standalone unit. Precast concrete.

Colour: Available in standard colours

White: BCPWH03, BCPWH06
Light Grey: BCPLG01, BCPLG02, BCPLG05
Dark Grey: BCPBL02
Black: BCPBL03
Buff: BCPYL01
Other colours available on request

Finish:

Concrete: Light Acid Etched
Timber: Coated with Danish oil
Other finishes available on request

Fixing: Surface Fixed

Unit should be placed on finished surface, using appropriate lifting equipment, no additional fixing required.

Packing:

Wrapped, banded & protected. 1 unit per pallet.
Unit to be removed from the pallet before installation.

Standard Shipping:

Dedicated delivery or pallet service available by request

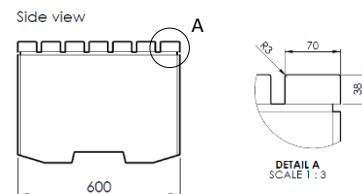
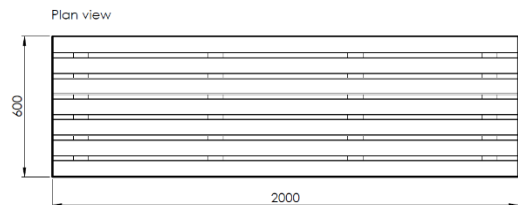
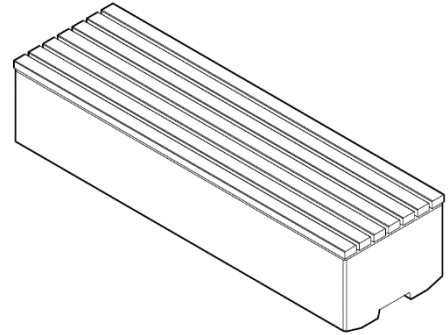

Technical Details:

Length: 2000mm
Depth: 600mm
Height: 450mm
Weight: 1195Kg